

 **LASER XT/3™**

PERSONAL COMPUTER

Operations Manual



Warning

This equipment generates and uses radio frequency energy. If it is not installed and used properly, that is, in strict accordance with the manufacturer's instructions, it may cause interference to radio and television reception.

It has been tested and found to comply with the limits for a Class B computing device in accordance with the specifications in Subpart J, Part 15, of FCC Rules. These rules are designed to provide reasonable protection against such interference in a residential installation. However, there is no guarantee that interference will not occur in a particular installation.

If this equipment does cause interference to radio or television reception, which can be determined by turning the equipment off and on, the user is encouraged to try to correct the interference by one or more of the following measures:

- * Reorient the receiving antenna
- * Relocate the computer with respect to the receiver
- * Move the computer away from the receiver
- * Plug the computer into a different outlet so that computer and receiver are on different branch circuits

If necessary, you should consult the dealer or an experienced radio/television technician for additional suggestions. You may find the following booklet prepared by the Federal Communications Commission helpful:

"How to Identify and Resolve Radio-TV Interference Problems"

This booklet is available from the U.S. Government Printing Office, Washington, DC20402, Stock No. 004-000-00345-4.

Warning :

To ensure that the use of this product does not contribute to interference. It is necessary to use shielded I/O cables.

Copyright

This manual is copyrighted with all rights reserved. No portion of this document may be copied or reproduced by any means without the prior consent in writing from Video Technology Computers, Inc.

While every precaution has been taken in the preparation of this book, Video Technology assumes no responsibility for errors or omissions. Neither is any liability assumed for damages resulting from the use of the information contained herein.

© Copyright 1988 by Video Technology Computers, Ltd.

IBM is a registered trademark of International Business Machines Corp.

Hercules is a registered trademark of Hercules Computer Technology.

Intel is a registered trademark of Intel Corporation.

MS-DOS is a registered trademark of Microsoft Corporation.

Lotus 1-2-3 is a registered trademark of Lotus Development Corporation.

DBase III is a registered trademark of Ashton-Tate.

WordPerfect is a registered trademark of WordPerfect Corporation.

Table of Contents

Chapter 1: Installation	5
Introduction	5
Preparing for the Installation	7
Checking the Contents of the Package	8
Hardware Features Overview	9
Connecting Peripherals	11
Starting the computer	13
Setting the System Clock	15
Operation Speed	16
Chapter 2: Using the Keyboard	17
The Keyboard Security Lock	17
Overview	18
Typewriter Keys	19
Numeric Keypad	22
Editing and Cursor Control Keys	25
Function Keys	27
Chapter 3: Introduction for New Users	29
Facts You Should Know	29
Introduction to MS-DOS	30
Storing Files on a Computer	31
Organizing Files into Directories	32
The Menu of MS-DOS Activities	34
How to Care for Your Computer	38
Diskette Care	39

Chapter 4: Enhancements	43
Special Note	43
Opening the System Unit	44
Road Map of Internal Components	45
Expanding System Memory to 640KB	47
Installing Parity RAM	51
Installing Expansion Cards	54
Installing an 8087 Math Co-Processor	56
Installing Expanded Memory	58
Using Expanded Memory	60
Installing a Hard Disk Drive	62
 Chapter 5: Troubleshooting Checklist	 63
Symptoms and Suggestions	63
Beeps	65
Display Messages	66
 Chapter 6: Further Reading (Getting More Help)	67
 Appendices:	 69
Appendix 1: Dip Switches and Settings	69
Appendix 2: The Multi I/O Card	73
Appendix 3: The Monochrome Graphics/ Color Graphics Card	79
Appendix 4: Glossary of Computer Terms	83

Chapter 1: Installation

Introduction

The computer is a high performance, expandable personal computer system which is designed specifically to be compatible with software and peripherals conforming to the popular MS-DOS and IBM PC-XT standard.

In some versions of the computer there may be differences in memory size and expansion cards installed, you may need to refer to a separate user's manual for any other expansion card installed.

- IBM PC/XT compatible processor running at 4.77 or 10 MHz.
- 512K memory, expandable to 1664K.
- 150 watt power supply.
- Two 5.25" 360K floppy drives, (some versions come with one 5.25" 360K and one 3.5" 720K floppy drive), additional space for one half-height hard disk drive.
- Some versions of computer have hard disk installed.
- 102 key enhanced keyboard.
- Multi I/O Card supporting Centronics parallel printer interface, RS232 serial interface, and game port for a joystick.
- Monochrome Graphics/Color Graphics Card, supporting RGB, Hercules, and composite monitors. Some versions of computer will have EGA card installed, which supports EGA, RGB, Hercules and composite monitors.

- Socket for an Intel 8087 math co-processor
- Eight expansion slots

In this first chapter, we will guide you through the installation of the computer, and introduce you to the basic structure of the computer. If you are unfamiliar with the meaning of a certain term, you can consult the glossary in Appendix 4 for a definition.

Preparing for the Installation

Before you install the computer, you should have a large clear area on which to work. Clear a tabletop large enough to hold the system unit and keyboard. The monitor can sit on top of the system unit if space is at a premium. You will need the following:

- A grounded, three-prong power outlet
- A small flathead screwdriver

These tools are sufficient for a normal installation. If you need to open up the system unit to install additional memory, disk drives, or expansion cards, you'll also need the following:

- A small Philips screwdriver
- A cup or an ashtray to hold loose screws

Checking the Contents of the Package

Carefully unpack the computer from its carton. Make sure the carton contains the following:

- The computer system unit
- A keyboard
- A power cord
- A video cable for composite monitors
- A package with manuals for MS-DOS® and GW/BASIC® (optional)
- A package containing four diskettes
- A warranty card

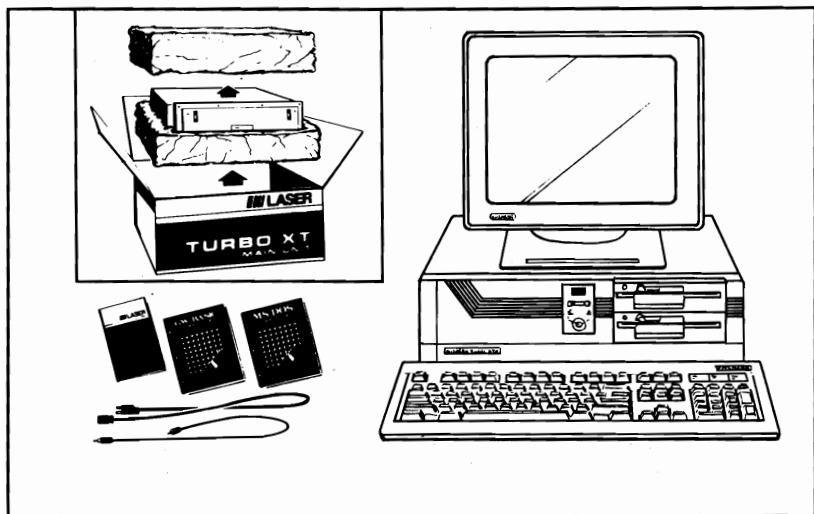

It is important to save the carton and packing materials in case you need to ship your unit in the future. Be sure to return the warranty card as soon as possible.

Hardware Features Overview

With the computer on a level surface, examine the following features on the front panel:

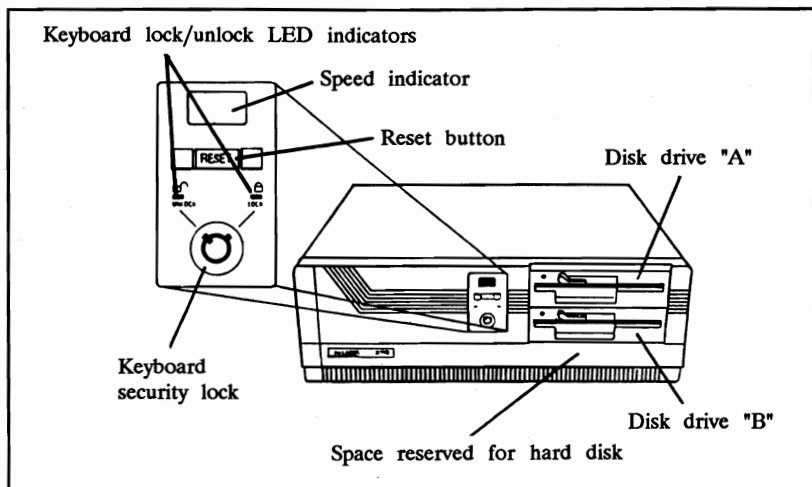

When the security lock is switched at left position, keyboard is unlocked and reset button is enabled; with the lock switched at right position, keyboard is locked and reset button is disabled.

The speed indicator is used to indicate the operation speed of the computer, a "5" will be displayed when computer operates at normal speed (4.77MHz) and a "10" will be displayed when the computer operates at high speed (10 MHz).

Notice the latch on each of the disk drives. With the latch in the horizontal position (pointing to the right), the drive is open, and ready to receive a diskette. After inserting a diskette, close the drive by turning the latch clockwise so it's pointing downwards.

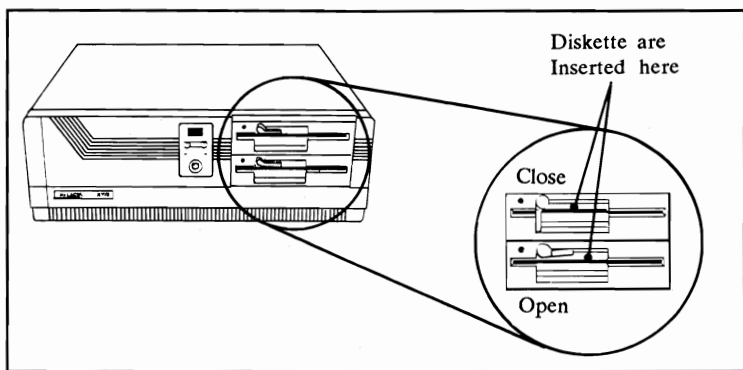

On the right side panel, you'll find the ON-OFF switch. The "1" setting means "ON", and "0" means "OFF".

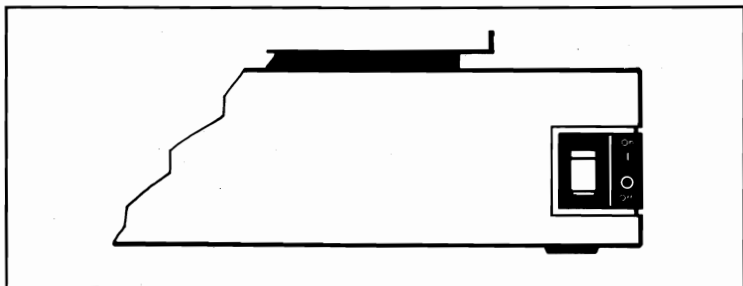

On the back side, there are several important connectors. You should notice:

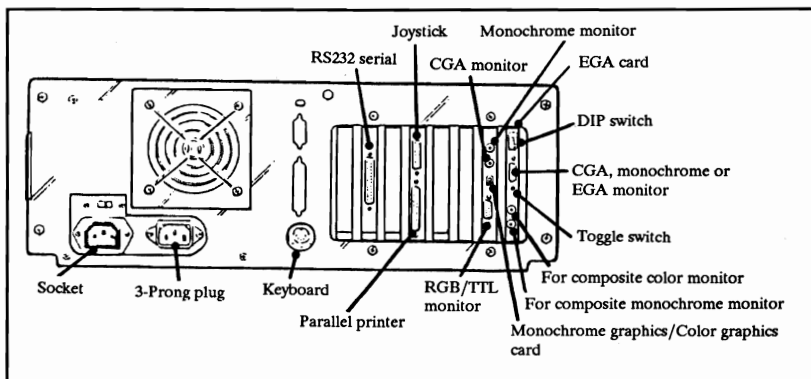

In normal installations, there is no need to open the system cabinet. If you will be adding enhancements, see Chapter 4 for instructions on opening the system unit.

Connecting Peripherals

1. Before connecting anything to your computer, make sure the power is off. The switch on the right panel should be in the down, or "0" position.
2. If you haven't done so already, remove the keyboard from its protective plastic bag. The keyboard cable attaches into the rounded five-pin socket on the back of the main unit:

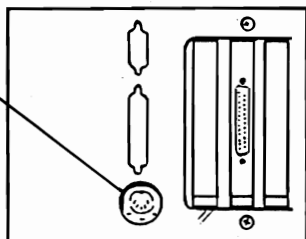

Make sure the plug is lined up with the socket. The small indentation should be pointing upwards.

3. Connect the monitor's cable into the appropriate place on the Monochrome Graphics / Color Graphics Card.

- For monochrome composite monitors, use the top round socket.
- For color, composite monitors, use the round socket in the middle, right above the slide switch
- For Hercules or RGB monitors, use the 9-pin "D" socket on the bottom of the adapter.

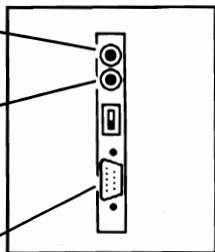

4. Connect the power cord from your monitor into a grounded, 3-prong wall outlet.
5. If you are using a Hercules or RGB monitor, set the slide switch to the up ("MDA") position for a TTL monochrome monitors, or to the down ("CGA") position for RGB color monitors.

RGB Color Monitors TTL Monochrome Monitors



6. Insert the main power cable that comes with the computer into the socket on the back of the system unit.

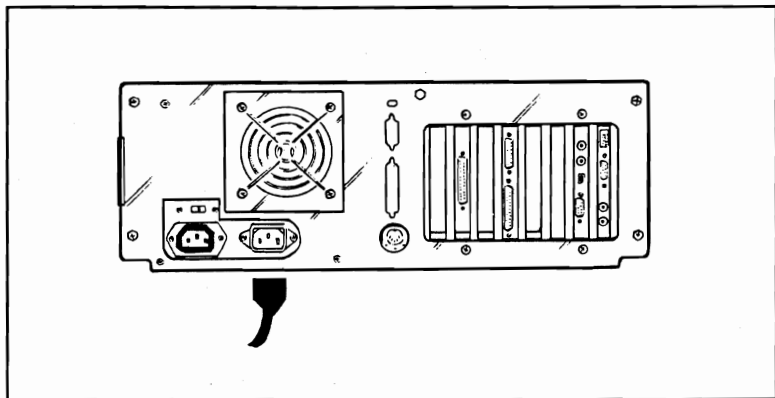

Plug the other end into a grounded, three-prong wall outlet.

7. Flip up the levers on the two floppy disk drives, and remove the sheets of cardboard that protect the drives during shipping. Remember to save these cards with the rest of the packaging.

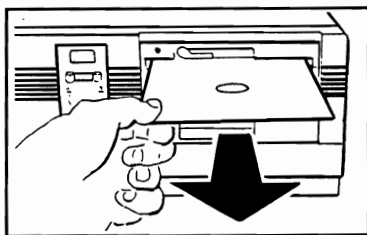

Starting the Computer

For system installed with hard disk, please follow the procedure:-

1. Turn on the power to your monitor. The ON/OFF switch is normally found on the front of the video screen.

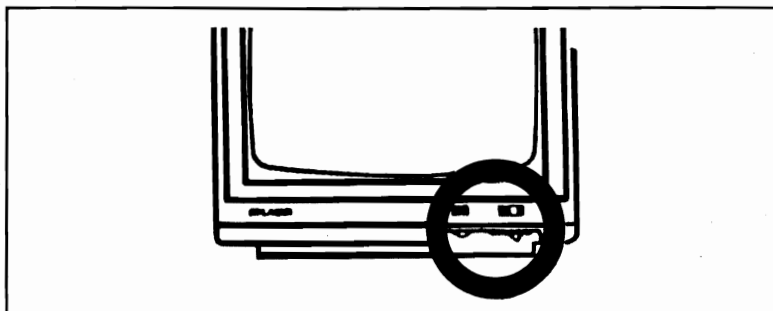

2. Turn on the power to the system unit by flipping the red power switch on the right side into the up position, labeled "1".
3. During the start-up procedure, the system performs a memory test, then loads the MS-DOS operating system. After several seconds, the following display will appear:

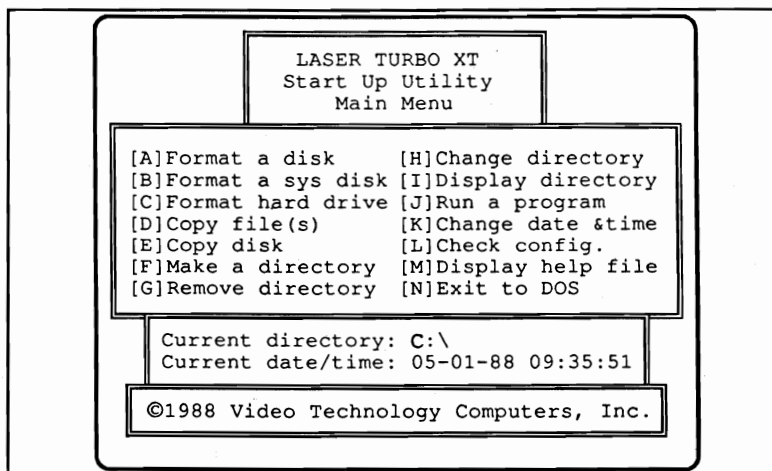

If your computer has no hard disk drive installed, then follow the following procedures:

Open the package of diskettes that came with the system. Locate the diskette labeled "Microsoft MS-DOS." Insert the diskette into the floppy drive with the label side up. The oval opening in the diskette should go in first.

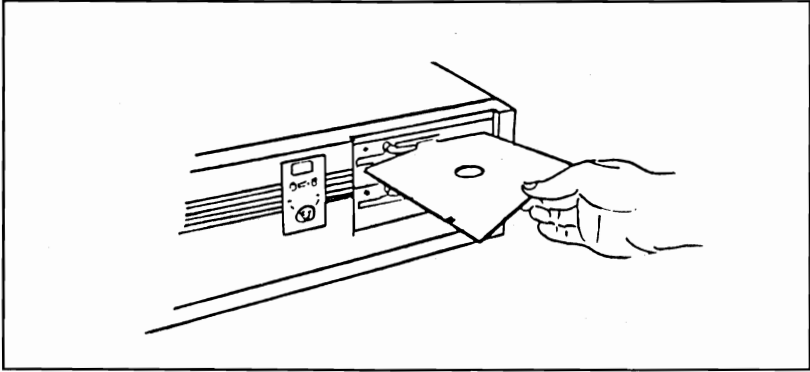

When the diskette is all the way into the drive, close the latch by moving the lever into the down position.

Then performs step 1 to step 3 as described above. For computer with hard disk installed, subdirectories are opened for MSDOS, GW/BASIC and start up utility. These users can practice with DOS, BASIC and start up commands.

Setting the System Clock

Your computer has its own clock to keep track of the date and time while you work. The clock is not set in the factory, so you'll need to set it the first time you use it.

1. The Computer Main Menu (As shown on page 9) should appear on the screen.
2. Type in the letter "K".

MS-DOS treats upper and lower case letters the same way, so it doesn't matter whether you're using capital or small letters.

3. The system will display the current date. Type in the correct date in the form:

mm-dd-yy <ENTER>

For example, to set the date for New Year's Day, 1988, you would type:

01-01-88 <ENTER>

4. The current time now appears on the screen. Press <ENTER> if no change is necessary, or type in the correct time using the format:

hh:mm:ss <ENTER>

The system's real-time clock is now set. Every time the computer is started, it will retrieve the correct date and time.

Operation Speed

The computer can operate at two different speeds. Some software requires you to operate at 4.77 MHz to maintain full compatibility with the original IBM PC-XT. When possible though, you should try to operate your computer at the "turbo speed" of 10 MHz. After warm or cold start, your computer will operate at 4.77MHz.

For 4.77MHz Operation:

Press

Ctrl

 and

% 5

 simultaneously.

For 10 MHz Turbo Operation:

Press

Ctrl

 and

* 8

 simultaneously.

Chapter 2: Using the Keyboard

The Keyboard Security Lock

The computer features a keyboard lock on the front panel. With the keyboard locked, no characters can be typed in to the computer, protecting your system from unwanted intruders.

You receive two keys with the unit. Make sure you store one in a safe place.

Two LEDs are used to indicate whether the keyboard is locked or unlocked. For example, when the keyboard is locked, the LED labelled with 'keyboard lock' will be on.



**Lock ON
Indicator**

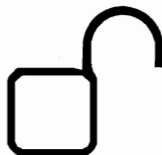

**Lock OFF
Indicator**

Overview

The keyboard is your primary means of communicating with your computer. Its layout roughly resembles an ordinary typewriter. To describe the keyboard clearly, it's helpful to divide it into four parts, each with its own function. In this chapter, we'll refer to these four areas:

- The Typewriter Keypad, with control keys
- The Numeric Keypad
- The Editing and Cursor Control keys
- The Function Keys

The diagram below shows the four principal keypads:

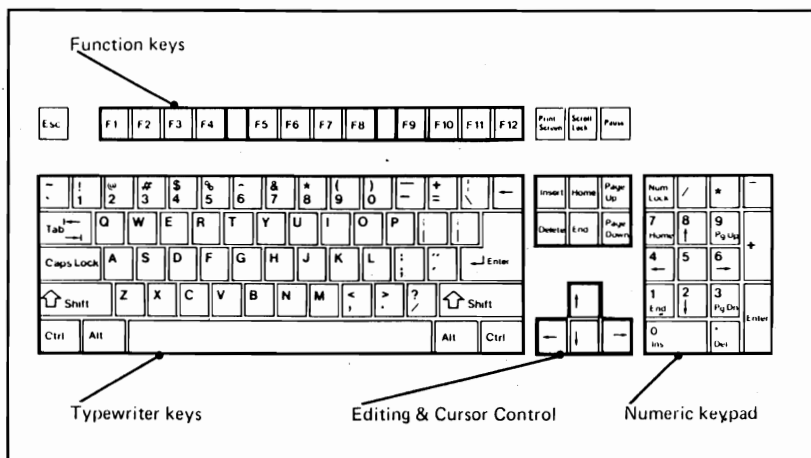

The Typewriter Keys

The typewriter area of the keyboard behaves a lot like a standard keyboard. Like a typewriter, the SHIFT key produces capital letters. To type the special characters shown above the numbers on the number keys, hold down the SHIFT key and press the appropriate key. For example, the SHIFT key with the number 1 produces an exclamation mark (!).

The diagram below shows several general keys like BACK-SPACE, SHIFT, TAB, and CAPS LOCK. You'll also notice several special control keys specifically associated with computer operations, including the ESC, CTRL, ALT, and ENTER keys.

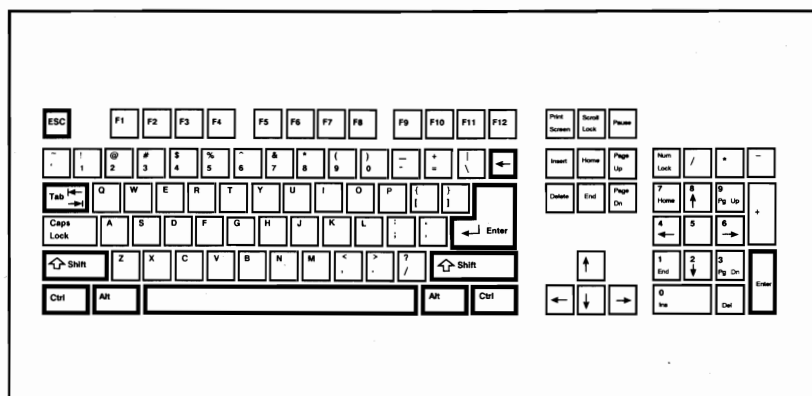

Here's a brief explanation of some important typewriter and control keys:

Caps Lock

CAPS LOCK... This is similar to the Shift-Lock key on an ordinary typewriter. With this key, you can type upper case letters without holding down the SHIFT key. When CAPS LOCK is engaged, the indicator light in the upper left hand corner of the keyboard lights up.

The CAPS LOCK key only affects the 26 letters of the alphabet. To get special symbols, you'll still need to press the SHIFT key.

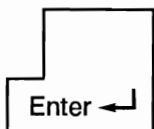

ENTER... As a RETURN key, it ends the line being typed and advances to the next line. As the ENTER key, it's used to execute commands you have typed.



SHIFT... For upper case letters, punctuation, or symbols, either one of the two SHIFT keys can be pressed. When the CAPS LOCK key is engaged, the SHIFT key acts as an "Un-Shift" key, allowing you to type lower case letters.



BACKSPACE... Like the Backspace key on a typewriter, it will erase one character to the left of the cursor.

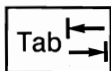

TAB... Like the Tab key on the typewriter, it moves the cursor to the next tab stop. Tab stops occur every eight characters, unless otherwise specified. Using SHIFT with TAB moves the cursor backwards to the previous tab stop.



ESC... The ESCAPE key has different meanings depending on the application you are using. In the BASIC language, for example, ESC erases a line from the screen.

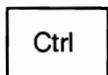

CTRL... The CONTROL key does nothing on its own. Like the SHIFT key, CTRL is used only in conjunction with other keys. CTRL performs many different functions depending on the application you are using.

Here are some examples of how CTRL is used in the MS-DOS operating system:

CTRL-SCROLL LOCK...BREAK

This function stops your program while it is running.

CTRL-PRINT SCREEN...*ECHO*

The computer prints each line as it is typed. To cancel the function, press CTRL-Print SCREEN again.

CTRL-NUM LOCK...*PAUSE*

This temporarily halts printing or a screen display. Press any key to continue.

CTRL-ALT-DEL...*SYSTEM RESET*

When these three keys are pressed together, the system resets and reloads the operating system.

Alt

ALT... Like the CTRL key, ALT performs no function on its own. It is used in conjunction with other keys to perform special functions. The meaning of ALT varies, depending on the application you're using.

While using the BASIC language, the ALT key allows you to quickly and easily enter BASIC keywords with a single keystroke. For example, ALT-I generates the word "INPUT". Here's a table of ALT key combinations in BASIC:

A.....	AUTO	M.....	MOTOR
B.....	BSAVE	N.....	NEXT
C.....	COLOR	O.....	OPEN
D.....	DELETE	P.....	PRINT
E.....	ELSE	Q.....	Undefined
F.....	FOR	R.....	RUN
G.....	GOTO	S.....	SCREEN
H.....	HEX\$	T.....	THEN
I.....	INPUT	U.....	USING
J.....	Undefined	V.....	VAL
K.....	KEY	W.....	WIDTH
L.....	LOCATE	X.....	XOR

The Numeric Keypad

The numeric keypad, shown below, performs a dual function. With the NUM LOCK key engaged (indicated by the status light in the upper right and corner of the keyboard), the keypad is useful for the rapid data entry of numbers. Without NUM LOCK, the keypad can be used to move the cursor or do special editing features.

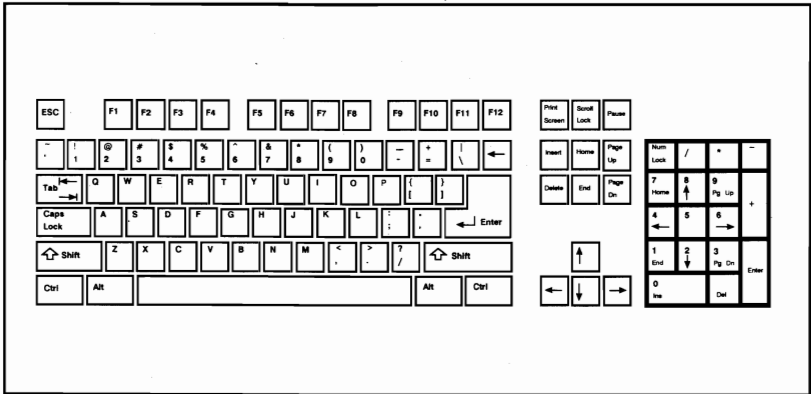

The 102 key enhanced keyboard provides a separate keypad for cursor control and editing (located immediately to the left of the numeric keypad). For this reason, most users will find it convenient to leave the NUM LOCK key on. This allows the numeric keypad to be used for rapid entry of numbers.

These keys operate the same regardless of the status of the NUM LOCK key:



ENTER... Works the same as the ENTER key on the Typewriter Keypad.

+

+...Displays the PLUS symbol.

-

-...Displays the MINUS symbol.

*

*...Displays the ASTERISK, used for multiplication.

/

/...Displays the SLASH, used for division.

These keys behave differently depending on the status of the NUM LOCK key:

	<u>NUM LOCK ON</u>	<u>NUM LOCK OFF</u>
1 End	The number 1	END... Moves the cursor to the end of the line.
2 ↓	The number 2	Moves the cursor down.
3 Pg Dn	The number 3	PG DN... Moves the cursor down one page, or 25 lines.
4 ←	The number 4	Moves the cursor left.
5	The number 5	No function



The number 6

Moves the cursor right.



The number 7

HOME... Moves the cursor to the screen's upper left hand corner.



The number 8

Moves the cursor up.



The number 9

PG UP... Moves the cursor up to the beginning of a page.



The number 0

INS... (Insert) Turns on "insert mode." Characters typed are inserted before text that already exists.



The DECIMAL POINT

DEL... (Delete) Erases one character at the position of the cursor.

Editing and Cursor Control Keys

This keypad sits between the Typewriter and Numeric keypads.

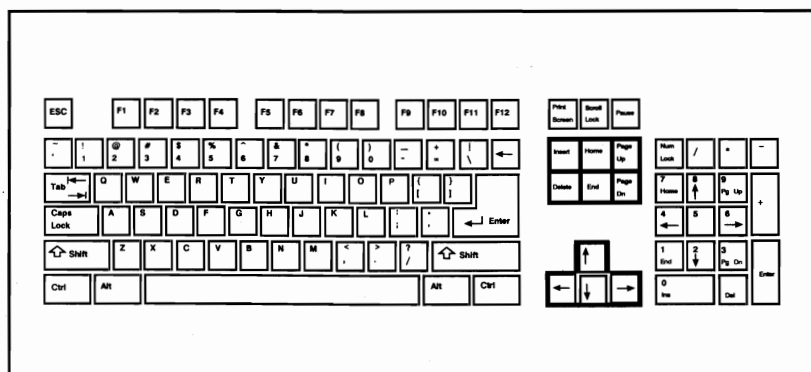

It performs the same functions as the keys on the Numeric keypad with the NUM LOCK key off:



HOME... Moves the cursor to the first character in the upper left hand corner of the screen.



CURSOR UP... Moves the cursor up one line.



CURSOR DOWN... Moves the cursor down one line.



CURSOR RIGHT... Moves the cursor one character to the right.



CURSOR LEFT... Moves the cursor left one character.



END... Moves the cursor to the right of the last character on the line.

Delete

DELETE... Deletes one character at the position of the cursor. All characters move left one position to fill in the deleted character.

Insert

INSERT... Turns on the "insert mode." Characters you type will be inserted before text that already exists, pushing the existing text to the right. With insert mode off, characters to the right are overwritten.

Page
Up

PAGE UP/PAGE DOWN... Its functions are defined by the application you are using. In general, these keys move the cursor up or down one page (25 lines).

Page
Dn

Function Keys

Located along the top half of the keyboard, these twelve function keys allow you to perform complex commands with a single keystroke.

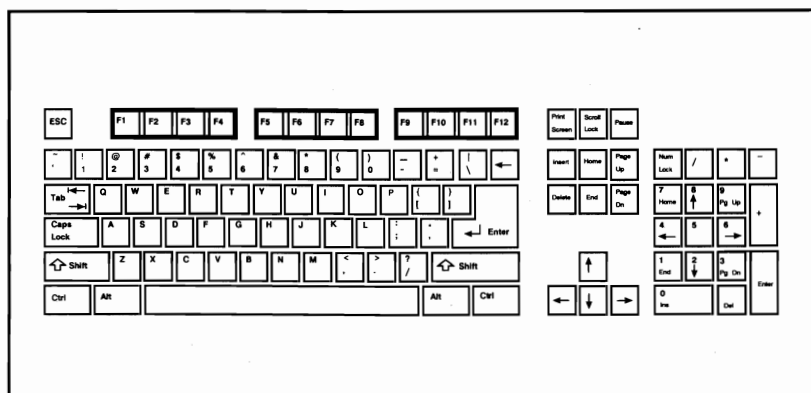

Most applications use function keys for different purposes. When running the MS-DOS operating system, the function keys perform the following activities:

F1

F1... Copies one character from a temporary storage area to the display. Each time you enter a command, MS-DOS store the command in a temporary storage area.

F2

F2... Displays all characters preceding a specified character from the temporary storage area.

F3

F3... Copies all remaining characters from the storage area to the display.

F4

F4... Deletes the characters preceding the specified character from the temporary storage area.

F5

F5... Enters the currently typed line into the temporary storage area.

Chapter 3: Introduction for New Users

Facts You Should Know

This chapter is intended for people with no computing experience. If you fall into this category, we hope you'll find some of the concepts introduced here to be helpful. Let's start with a few general facts:

- A computer is not like a television set that you can simply take out of the box and plug in. It will require both time and patience to learn. If you try to learn things too quickly under pressure, you may get frustrated. We recommend leaving plenty of time for learning.
- There is a fan on the back of the computer system unit. This fan is absolutely essential for cooling the internal components. Do not block this fan! Make sure you leave plenty of space for air to circulate behind the computer.
- Static electricity can damage your system. Your body picks up static electricity without you even knowing it, and even a mild static shock can harm delicate computer components. To protect against static shock, always touch the metal chassis of your system unit before touching other electronics.
- Electrical interference and power surges can destroy computer components. Do not plug your computer into an outlet that powers heavy equipment, like copiers or refrigerators. If you live in a rural area with unreliable power, you may want to purchase a surge suppressor to protect your components from overload.

Introduction to MS-DOS

MS-DOS stands for MicroSoft Disk Operating System. An operating system is a group of programs that acts as:

- A manager for your computer, monitor, and peripherals
- An interpreter, conveying your instructions to the computer

If you plan on running application programs only (software written to perform specific tasks, e.g. Lotus 1-2-3[®] or WordPerfect[®]), you actually need to know very little about the MS-DOS operating system. On the other hand, if you plan on writing your own programs, you may have to learn quite a bit about it.

We recommend learning enough about MS-DOS so you can take advantages of all the features of your computer. We will provide a basic introduction to MS-DOS in this booklet. To find out more, you should consult the *MS-DOS User's Guide* included with your system.

There are several excellent instruction manuals and tutorials written about MS-DOS. Refer to Chapter 6 for a listing of relevant books.

Storing Files on a Computer

To learn more about how your computer works, you have to learn how MS-DOS organizes and stores data.

All information on disks is stored in *files*. A file is simply a collection of information. Computer files can be broken down into three categories:

- **System Files...** contain MS-DOS information that manages the computer operations.
- **Program Files...** contain information that lets your computer perform a series of specific tasks.
- **Data Files...** contain information which you enter, such as documents created in a word processing package, or worksheets created with a spreadsheet package (like Lotus 1-2-3).

All files are referred to by their **filename**. MS-DOS filenames may not be more than eight characters long. Filenames can contain letters, numbers, and the symbols \$ & # % ' () - @ ^ { } or !.

To further identify a file, a filename can contain an **extension** of up to three characters. The extension always appears at the end of the of a filename, preceded by a period. Extensions are a good way to categorize files into efficient groupings. For example, files containing Lotus spreadsheets end in the extension **.WKS** - an abbreviation for worksheet, while word processing documents could end in **.DOC** - an abbreviation for document.

The following are all valid MS-DOS filenames:

SALESLTR.DOC	Checking.bal	File#1.TXT
QTR1.WKS	MyFile	WIN.INI
Menu.BAS	Work.TST	XXX.xxx

Organizing Files into Directories

Files on a disk are grouped into *directories*. A directory is simply a "Table of Contents" for the disk. For each file residing on a disk, an entry is made in a directory recording the name of the file, its size, and its location on the disk, data of creation, attributes.

Every disk contains one main directory called the root *directory*. The root directory serves as a "master index" for the disk. When you format a new diskette for use on your computer, the root directory is automatically created. When you start up the computer, you are operating from the root directory.

The root directory can be subdivided into more directories for the sake of organization. For example, all word processing documents could be stored in a directory named "Letters". Checkbook balances and your home budget could be grouped into a directory named "Finance".

For many purposes, especially if you are using floppy disks only, you may not need any additional directories. The root directory alone should suffice. However, when you add a hard disk, organizing your files into directories becomes essential because the hard disk is capable of storing thousands of files.

To summarize, the root directory can contain several subdirectories, and each subdirectory in turn can contain other subdirectories. In the illustration below, directory names appear in boldface text, while file names appear in normal text:

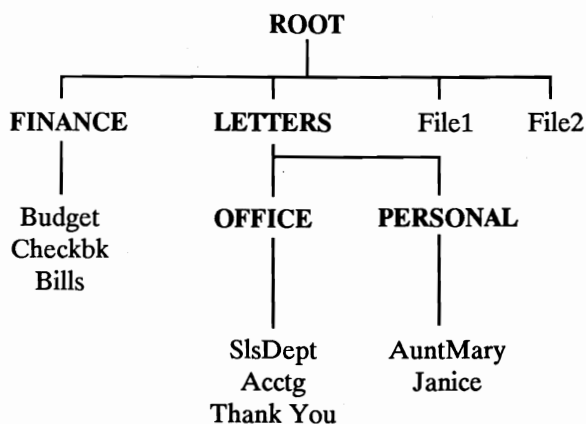

The rules for naming directories are the same as those for naming files. Names can be up to eight characters long, and contain letters, numbers, and the symbols \$ & # % ' () - @ ^ { } or !.

The Menu of MS-DOS Activities

The computer features a helpful menu of the most common MS-DOS commands. The menu appears whenever you start up the machine:

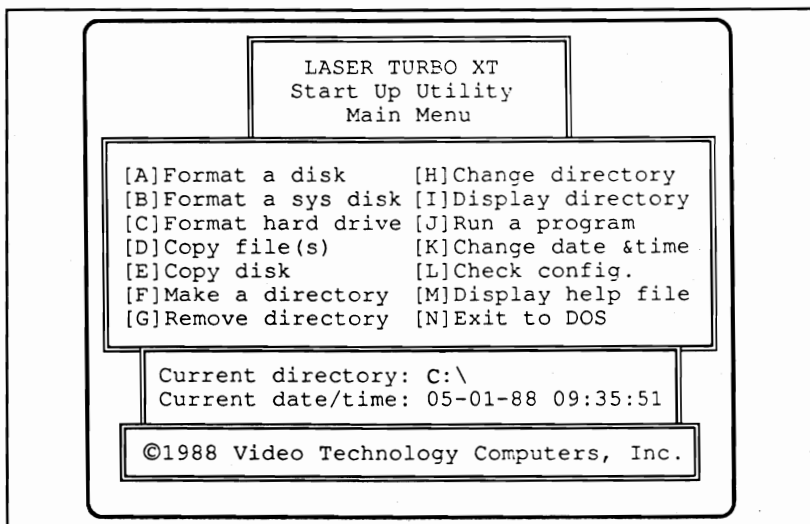

This menu gives you an easy-to-use tool for working with MS-DOS. With one keystroke, you can perform several common functions. To use the menu:

1. Touch the letter corresponding to the activity you wish to perform. For example, you would press the letter **D** to copy a file.
2. The computer will ask you questions pertaining to the command. After typing in your answer, press the **ENTER** key.

The following is an overview of the menu options. For more information about these commands, consult the *MS-DOS User's Guide* included with the computer.

<u>Command</u>	<u>Function</u>	<u>Options</u>
[A] Format a disk	Prepare a new, blank diskette for use on your system. You must have the file FORMAT.EXE in the current directory.	<p>*Do you have FORMAT.EXE in the current directory (Y or N)?</p> <p>*Enter the drive letter for format (A: - D:)</p>
[B] Format a sys disk	Creates a diskette capable of being used as a system start-up disk.	<p>*Do you have FORMAT.EXE in the current directory (Y or N)?</p> <p>*Enter the drive letter for system format (A: - D:)</p>
[C] Format hard drive	Prepares a hard disk for use on the system. This command should only be done once, the first time the hard disk is used.	<p>*Do you have HARDFORMAT.BAT in the current directory (Y or N)?</p> <p>*This command will completely ERASE the hard disk. Are you sure you want to proceed? (Y or N)</p>
[D] Copy file(s)	Copies a file from one disk to another or one directory to another. Can also copy a file within a directory.	<p>*Enter the source drive (A: - D:). This is the drive where the file is located currently.</p> <p>*Enter the destination drive (A: - D:). This is where you want the new file to go.</p> <p>*Enter the file name to copy. If you leave this entry blank, the computer will assume you want to copy all files in the current directory.</p>

<u>Command</u>	<u>Function</u>	<u>Options</u>
[E] Copy disk	Copies the contents of a diskette in disk drive "A" to a diskette in drive "B". You must have the file DISKCOPY.EXE in the current directory.	*Do you have DISKCOPY.EXE in the current directory (Y or N)?
[F] Make a directory	Creates a new directory or subdirectory.	*Enter the name for the new directory.
[G] Remove directory	Deletes a directory from the disk. The directory must be empty of files before it can be removed.	*The directory must have 0 files for this to work. Does it? (Y or N) *Enter the name of the directory to remove.
[H] Change directory	Changes the "current directory" to something else.	*Enter the drive letter. (A: - D:) *Enter new directory name.
[I] Display directory	Lists information about the files in a certain directory.	*Enter qualifier (Default = *.*). If you leave this entry blank, all files will be listed.
[J] Run a program	Used to start-up an application program, like a spreadsheet or word processing package.	*Enter the name of the program. If the program is not located in the current directory, you'll need to specify the drive letter and directory name.
[K] Change date & time	Used to set or change the real-time clock in the system.	*Do you have GETCLOCK.EXE and SETCLOCK.EXE in the current directory (Y or N)? *What is the current date? (Use MM-DD-YY format) *What is the current time? (Use HH:MM:SS format)

<u>Command</u>	<u>Function</u>	<u>Options</u>
[L] Check config.	Displays details about your system configuration (i.e. how many drives, how much memory).	*Do you have WHATAMI.EXE in the current directory (Y or N)?
[M] Display help file	Prints a copy of the help file pertaining to these menu selections.	*Do you have HELPTXT in the current directory (Y or N)?
[N] Exit to DOS	Ends this Menu Program and returns you to the standard DOS prompt. To restart the menu program, enter MENU at the DOS prompt.	*No options

The MENU program allows you to perform several activities without having to learn MS-DOS in great detail. However, we recommend becoming familiar with the most common and most useful MS-DOS commands. for further information consult the *MS-DOS User's Guide* or one of the books suggested in Chapter 6.

How to Care for Your Computer

1. Until you gain a great deal of experience, do not attempt to probe the inside of your computer, particularly the power supply. Dangerous levels of high voltage exist. Contact your dealer for service if necessary.
2. Turn off the computer and unplug it from the wall before you install anything inside the system unit, such as an expansion card or memory chips. Failure to do so will result in serious, irreparable damage to both the computer and the add-on device.
3. Keep the computer away from excessive heat, humidity, dust, or moisture.
4. Do not cover the fan or ventilation holes on the back panel of the computer.
5. Do not use thinner, oil, or petroleum-based cleaners on the cabinet or keyboard. Use only a damp cloth (with a mild detergent, if necessary) for cleaning. Make sure the power is off.
6. If you need to move your computer system, use the original packaging to shield it from shock. If the system includes a hard disk drive, you must run a special protection program before moving. Refer to your hard disk manual for details.
7. Do not drop the main unit. Handle it with care.
8. Do not attempt to use your computer underwater.

Diskette Care

The 5-1/4" Floppy Disk Drive of the computer uses 5-1/4", double sided, double density (40 tracks per inch), soft sectored floppy diskettes. These diskettes are capable of holding 360K (368,640 bytes).

Each floppy diskette has a write-protect notch on its side, as shown in this diagram:

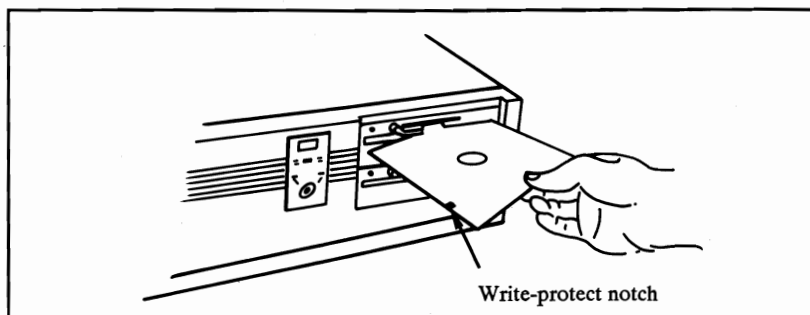

If this notch is covered, the computer will **not** let you write to the diskette. This is a good way to make sure no one erases diskettes that are absolutely crucial.

Always handle your floppy diskettes carefully. A small scratch, stain, or even a speck of dust can destroy the information stored on the diskette. The following guidelines will help prolong the useful life of your diskettes and may help prevent the loss of important data:

- Always keep diskettes in their protective envelope when not in use.
- Never touch the diskette's shiny exposed surface.
- Don't bend diskettes.
- Keep diskettes away from magnetic fields (transformers, motors, magnets, TVs, radios).

- Never lay a diskette on top of or next to the computer system unit.
- Write only on a diskette label, and only with a soft felt-tip pen. Never use a ball point pen to write on diskettes.
- Keep diskettes out of direct sunlight and away from excessive heat. They melt easily.
- Some versions of the computer has a 720K 3 1/2" Floppy disk drive installed. These drives use 3 1/2" Floppy diskettes: which are capable of holding 720K bytes maximally.

Hints on using 3-1/2" drive

Before you are going to use the 3-1/2" drive, there are some basic concept and terminology you need to know.

A physical drive is a drive that is physically connected to the computer.

A logical drive is a drive that can be accessed through the "drive letter" assigned, e.g. A:, B:.

Thus there may be more logical drives than physical drives, since two or more logical drives may refer to the same physical drive.

An external drive is the drive that is created by the file CONFIG.SYS. The drive letter for that external drive is specified by assigning parameters on the CONFIG.SYS file. The installation procedure of external drive is shown below.

Normally, after you have connected a 3.5" micro floppy disk drive to your computer, you can access the drive as usual. However, you will not be able to format a 3.5" diskette with 720KB storage capacity. This is expected because DOS presumes your drive is a 360KB, 5.25" drive. To use your 3.5 inch floppy disk drive as a 720KB drive, you should follow the procedures below:

(A) If you are using DOS 3.2

1. Insert a DOS disk into drive A.
2. If your 3.5" disk drive is the second drive, create the CONFIG.SYS file and include the following line:

```
drivparm = /d:1
```

Otherwise, change the parameter "d:1" to "d:0."

3. Warm boot the system.

3.5" disks can now be formatted on 720KB.

(B) If you are using DOS 3.3

1. Insert a DOS disk which contains the DRIVER.SYS into drive A.
2. If your 3.5" disk drive is the second drive, create the CONFIG.SYS file and include the follow line:

```
device = driver.sys/d:1
```

This line tells the system to install an external drive C:. The parameter /d:1 specifies that the external drive C: is logically linked to the second physical drive B:. That is to say, you can access physical drive B: via logical drive C: in addition to drive B:.

If your 3.5" disk drive is the first drive, change the parameter "d:1" to "d:0."

3. Warm boot the system.

The message "Loaded External Disk Driver for Drive C" will be displayed which indicates the external drive is successfully installed.

3.5" disks can now be formatted in 720KB via drive C: in the 3.5" disk drive. While drive C: is specifically created to allow formatting in 720KB, normal disk access through drive B: (drive A: for first drive) is still permitted, except that the disk can only be formatted in 360KB, not 720KB.

New diskettes must be formatted before they can be used on your computer. Refer to the "How to Format Your Disks" section in the *MS-DOS User's Guide*.

Chapter 4: Enhancements

Special Note

The enhancements described in this chapter let you improve the power and performance of your computer system. The parts required for each enhancement are available from your dealer.

All these enhancements require you to open the system unit and install add-on accessories inside. Furthermore, some of the instructions may seem complicated, especially for first time computer users. If you are a new computer user, you may want to have your dealer install the enhancements.

Before opening your system unit, make sure the power to your computer is OFF, and the unit is unplugged from the wall socket. Attempting to install expansion cards, memory, or other internal components with the computer plugged in will cause serious and irreparable damage to both the computer and the add-on accessory.

Opening the System Unit

To open the computer system unit, you'll need a Philips screwdriver. Begin by placing the computer system unit on a flat surface. Unplug the power cord from the wall outlet!

Looking at the back of the system unit, there are five screws you need to remove:

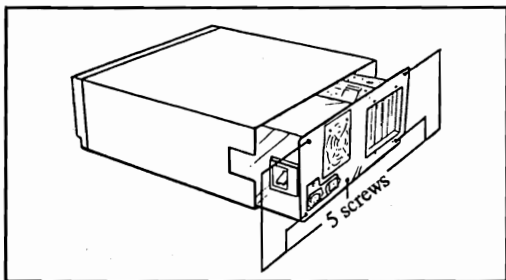

Remove the screws and put them in a safe place. Grasp the cover of the chassis with both hands, and slide it forward and off, as shown below.

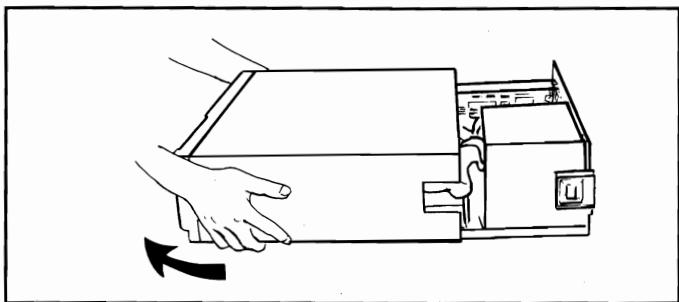

There are several ribbon cables present in the system. If you encounter any resistance while you are removing the system cover, reach in and gently press down on these cables. Do not attempt to yank off the cover if it's stuck on a cable.

Road Map of Internal Components

With the system unit open, this is a good time to get a general overview of the internal parts of the system unit:

Notice the following areas of the system unit:

- System Board
- Expansion Slots
- Hard Disk Controller
- Multiple Input-Output (I-O) Card
- EGA card
- Floppy Drives "A" and 5 1/4", 360K
- Floppy Drive "B" 3 1/2", 720K
- Socket for an 8087 Math Co-Processor
- Hard disk "C"
- Power Supply
- Sockets for Memory Expansion to 640K.
- Ribbon Cables
- 4 Empty Rows for Installing Expanded Memory
- 2 DIP Switches

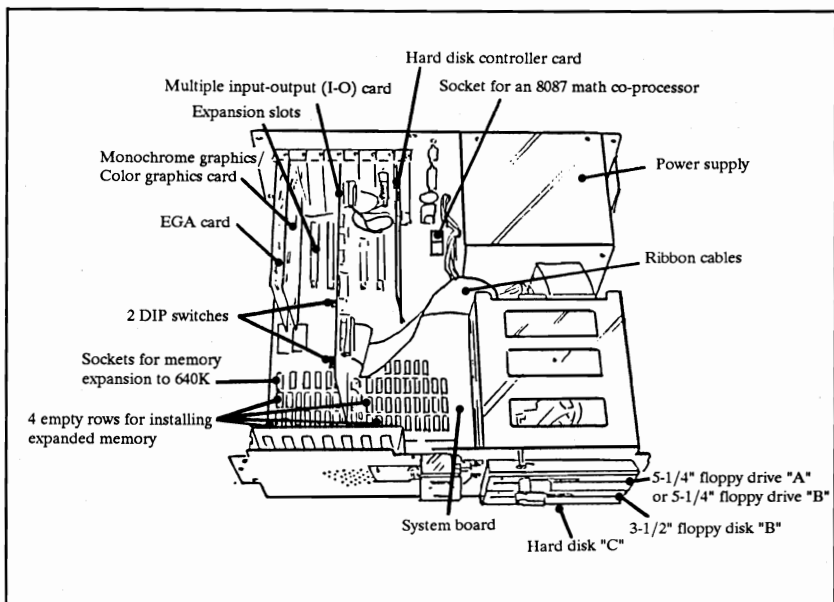

Expanding System Memory to 640K

MS-DOS itself recognizes up to 640K of memory. Because the computer comes with 512K of memory, one of the first enhancements we recommend is expanding the system memory to its full 640K.

There are four simple tricks to successfully installing memory on the system board:

1. Purchase the correct memory chips.
2. Install the chips in the right place on the system board.
3. Make sure the chips are pointing the right way when you install them in their sockets.
4. Make sure none of the pins on the chip bend when you are pushing the chip into the socket.
5. Set the proper switch on the system board so the computer recognizes all 640K.

Let's take each step in detail. As always, before you install anything, Make sure the computer is unplugged from the wall outlet!

1. **Purchase the correct memory chips.**

Ask your dealer for four (4) 4464 RAM chips (64K RAM x 4)

The chips must be 150 nanoseconds (150ns) or faster.

2. Install the chips in the right sockets on the system board.

As shown in this diagram, the sockets for the four 4464 RAM chips are highlighted. The chips will be installed in sockets U36, U37, U38 and U39.

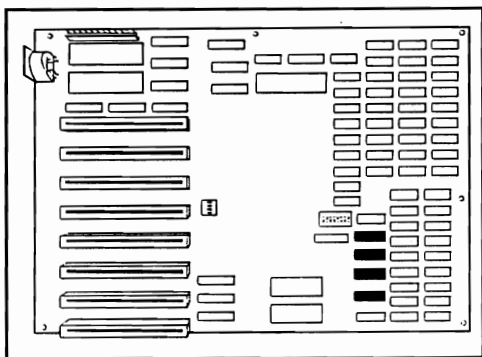

3. Make sure the chips are pointing the right way.

Take a careful look at the top of the memory chips. You'll see a small indentation, notch, or marking at one end of the chip.

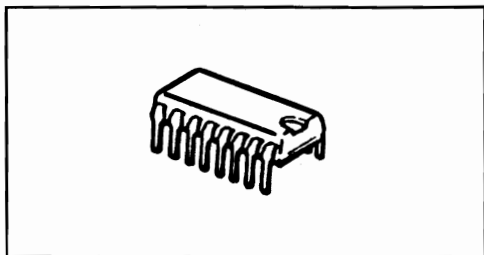

Examine the two rows of memory chips currently installed in the computer. Notice the indentation on the chips is pointing towards the center of the system board (toward the back of the unit).

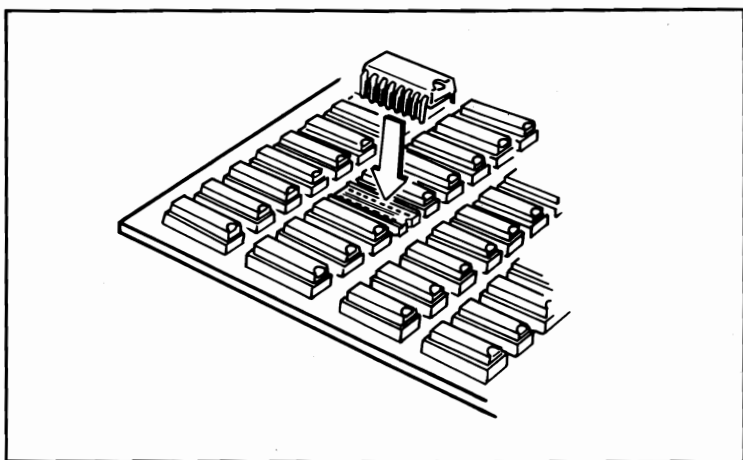

You must install the new memory chips with the indentation facing the back of the system unit, in the exact same direction as the other memory chips.

- 4. Make sure none of the pins on the chip bend when you insert them into their sockets.**

Now that you know what kind of chips to use, where they go, and which direction they point, you are ready to actually install the RAM chips.

With the chip facing the right direction, carefully place the prongs from the RAM chip into the holes on the socket. Press downward. No force is required to install RAM chips. If you have to press hard, you are probably bending a pin.

The pins that connect each chip to its socket are easily bent out of shape. After installing the RAM chip, make sure no pins are bent or protruding from the socket.

Keeping all these things in mind, install the four 4464 RAM chips in sockets U36, U37, U38, and U39.

5. Set the switch on the system board so the computer recognizes all 640K.

The computer has banks of switches labeled SW1 and SW2. SW1 is a bank switch having 8, small switches and SW2 is a bank switch having four small switches. Locate Switch Bank #1 (SW1) as shown in the diagram:

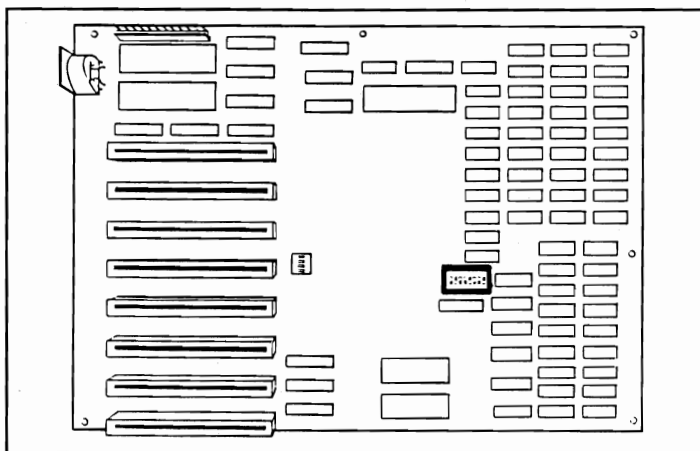

Right now, switch 3 is ON. To set your system to 640K of memory, turn switch 3 OFF.

You can use the tip of a pencil or the head of a small screwdriver to move the switch.

Installing Parity RAM

RAM parity is a method the computer can use to continually monitor and test the performance and reliability of the memory chips.

The advantage of parity RAM is the error-checking it performs. Parity RAM spots potential failure in the RAM chips, and informs the user. Without parity RAM, your system may "lock up" if a failure occurs, providing no indication of the cause of the failure.

The disadvantage of parity RAM is its cost. We feel the price of parity RAM far outweighs the benefits it produces, so we recommend you don't make the extra investment for parity RAM.

In case you really want to install it, here are the steps. As always, before you install anything, **MAKE SURE THE COMPUTER IS UNPLUGGED FROM THE WALL OUTLET!**

1. Purchase the proper chips.

- Ask your dealer for two (2) 4164 RAM chips (64K RAM x 1), and two (2) 41256 RAM chips (256K RAM x 1).
- The chips must be be 150 nanoseconds (150ns) or faster.

2. Install the chips in the right sockets on the system board.

As shown in the diagram, the two 4164 chips go in sockets U35 and U50, while the two 41256 chips go in sockets U25 and U41.

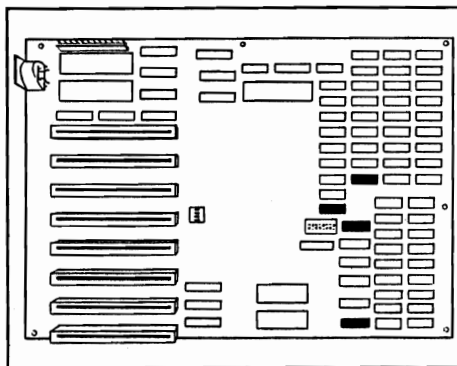

3. Make sure the chips are pointing the right way.

As before, notice the indentation on the chips is pointing towards the center of the system board (toward the back of the unit). Make sure you install the parity RAM with the chips pointing in the same direction.

4. Press the chips into place in their proper sockets.

Once again, make sure no pins are bent or protruding from the socket.

5. You'll need to adjust a jumper to tell the computer that parity RAM is now enabled.

In the diagram on the next page, locate jumper JP5 located almost right next to SW1:

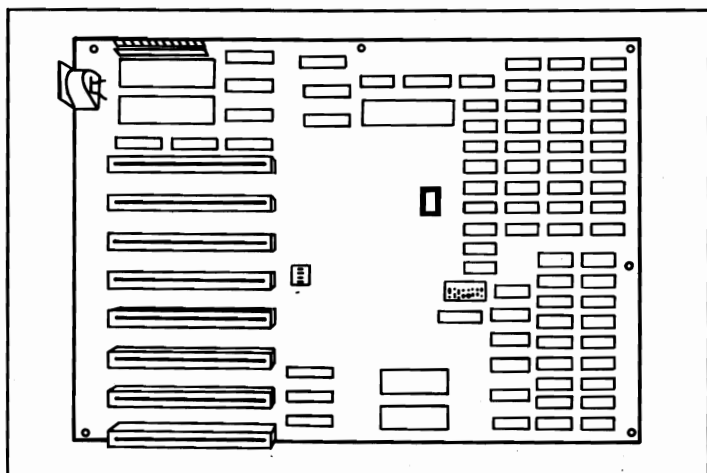

Notice that the jumper is currently set for RAM Parity disabled.

RAM Parity Disabled



Jumper JP5

To enable RAM parity, gently lift the jumper of the two pins it's on now, and place it on the two pins shown below.

RAM Parity Enabled



Jumper JP5

Jumper JP7 is now set to recognize that parity memory is installed.

Installing Expansion Cards

Installing expansion cards into slots is a very simple process. With six expansion slots free, you have a lot of room to enhance the capabilities of your computer.

1. Before you begin:

- Unplug the computer from the wall outlet.
- Remember that circuit boards are sensitive to static electricity. Rid your hands of static electricity by touching the system chassis every time before touching a circuit board.

2. Choose an empty slot and remove the screw holding the slot cover to the back of the chassis.

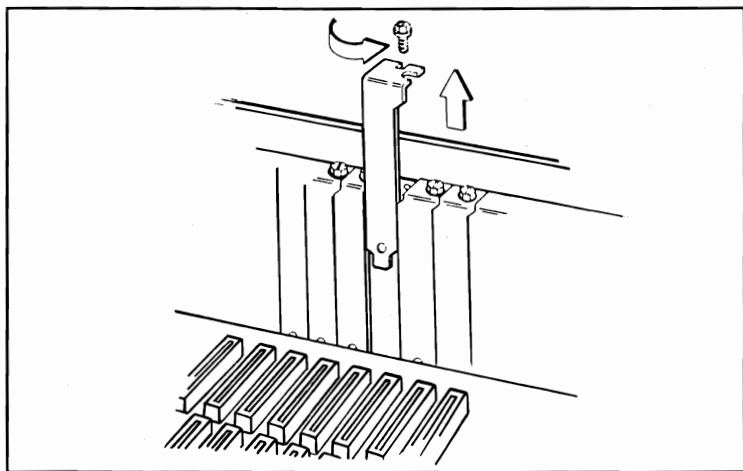

3. Slide the card into place, with its tab meeting the grooves in the expansion slot.

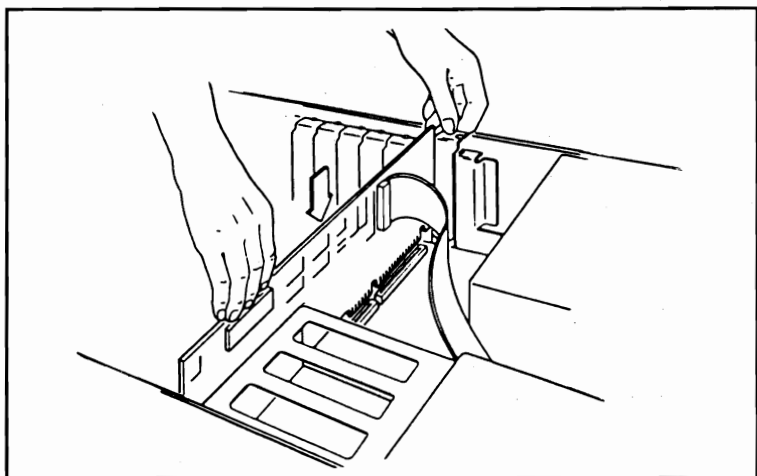

4. Replace the slot cover screw, which will secure the endplate bracket of the card to the back of the system unit.

Installing an 8087 Math Co-Processor

The computer has a socket available for an 8087 math co-processor chip. This chip is specialized to do floating point arithmetic very fast. If you are working intensively with enormous spreadsheets or mathematics, it could speed “number crunching” significantly. It’s manufactured by Intel, and should be purchased from an authorized Intel dealer.

1. Purchase the correct chip. Ask the dealer for an 8087-1 math co-processor. The 8087-1 is necessary to take full advantage of your 10 MHz turbo speed.
2. Identify the correct socket. The 8087-1 is installed in the long empty socket located immediately next to the CPU:
3. Make sure the chip is pointing in the right direction. The notch on the 8087-1 should be pointing to the rear of the unit (towards the back panel).

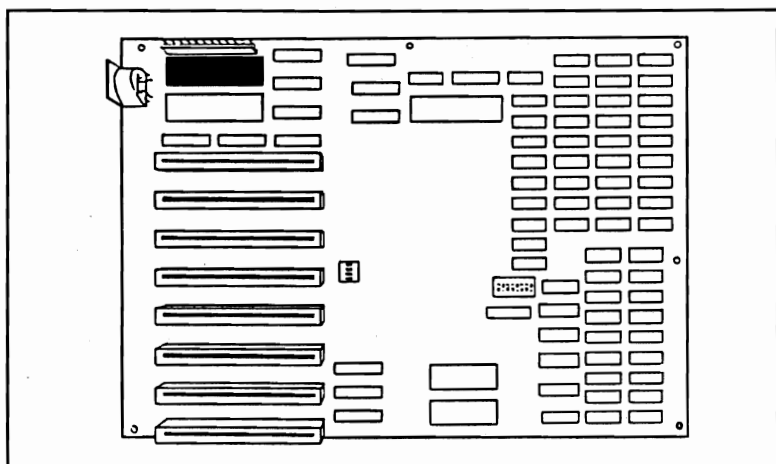

3. Make sure the chip is pointing in the right direction. The notch on the 8087-1 should be pointing to the rear of the unit (towards the back panel).

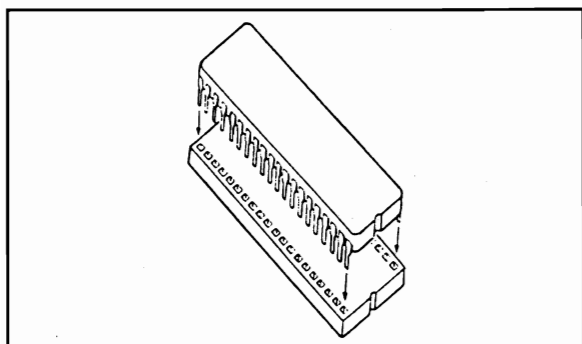

4. Press the co-processor chip into place in its socket. Once again, make sure none of the pins are bent or protruding from the socket.
5. Set the switch on the system board so the computer recognizes the 8087 math co-processor. Locate Switch Bank #1 (SW1) as shown in the diagram:



Right now, switch 2 is ON. To set your system for the 8087-1, turn switch 2 OFF.



Installing Expanded Memory

As mentioned before, MS-DOS only recognizes up to 640K of memory. Any memory above and beyond 640K is referred to as *expanded memory*.

Some applications like Lotus 1-2-3 and Dbase III make use of up to 8 megabytes (8 MB, or 8,192K) of expanded memory. On your computer system board, there is room for you to add one megabyte (1 MB) of expanded memory.

You must add expanded memory in increments of 512K, so you can add 512K or 1 MB.

As always, before you install anything, **MAKE SURE THE COMPUTER IS UNPLUGGED FROM THE WALL OUTLET!**

1. Purchase the correct memory chips. For every 512K of expanded memory you install:

Ask your dealer for sixteen (16) 41256 RAM chips (256K RAM x 1). If you plan on using RAM parity, you'll need eighteen instead of sixteen.

The chips must be 150 nanoseconds (150ns) or faster.

2. Install the chips in the right sockets on the system board.

In the diagram below, notice there are two banks of empty sockets for installing expanded memory. The banks are labeled, Bank 0, Bank 1.

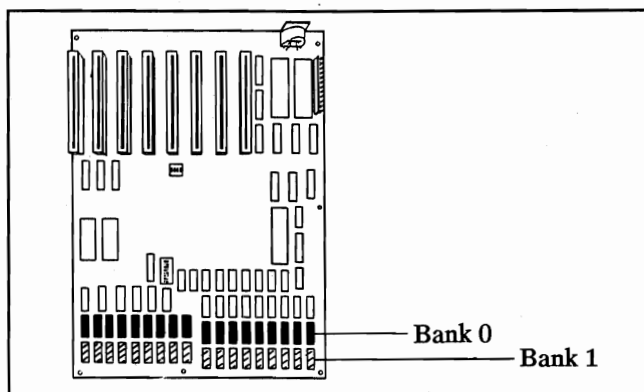

The first 512K of expanded memory goes in Bank 0. The first sixteen chips get installed in sockets U50 through U57, and U60 through U67. If you are using parity RAM, install another chip at U58 and U59.

If you are installing 1 MB of expanded memory, fill up Bank 1.

1. Remember, the socket at U76 and U77 need to be filled only if you are using RAM parity-checking.

3. Make sure the chips are pointing the right way.

Make sure you install the RAM chips with the indentations pointing towards the center of the system board (toward the back of the unit).

4. Press the chips into place in their proper sockets.

Once again, make sure no pins are bent or protruding from the socket.

5. Set the switch on the system board so the computer recognizes the correct amount of expanded memory.

Locate Switch Bank #2 (SW2) as shown in the diagram:

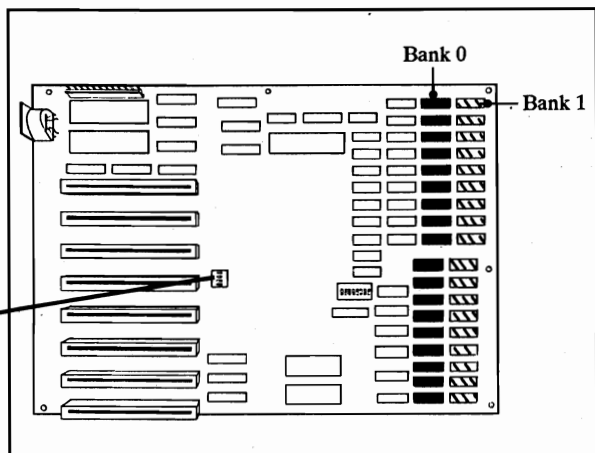
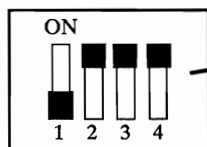

Right now, all the switches are on. To set your system to recognize the correct amount of expanded memory, set the switches as above:

Using Expanded Memory

As mentioned previously, MS-DOS does not recognize any memory past 640K. All memory over 640K is called expanded memory.

Some software packages are written to automatically recognize expanded memory. For example, Lotus 1-2-3 and Microsoft Windows 2.0 take full advantage of expanded memory. Other programs will not recognize expanded memory at all. It depends specifically on the application you are using.

We have supplied two software programs which are used with your expanded memory. The first program is EMM.SYS. *It must be installed before the expanded memory can be used.* The second program is ERAMDISK.SYS, a helpful program for implementing a RAM disk in expanded memory.

EMM.SYS

- The MS-DOS driver for managing expanded memory.
- The following line must appear in the file CONFIG.SYS:
DEVICE = EMM.SYS M3 I0

ERAMDISK.SYS

This is a driver to turn your expanded memory into a RAM disk. A RAM disk program sets aside a portion of memory and treats it as if it were a physical disk drive. In other words, with two floppy disk drives on your system (Drive "A" and "B"), the RAM disk becomes Drive "C". If you also have a hard disk installed, the RAM disk becomes Drive "D".

- To use 512K of expanded memory as a RAM disk, the following line must appear in CONFIG.SYS:
DEVICE = ERAMDISK.SYS 512
- To use 1MB of expanded memory as a RAM disk, the following line must appear in CONFIG.SYS:
DEVICE = ERAMDISK.SYS 1024

Installing a Hard Disk Drive

If your computer is equipped with a hard disk drive, you will need to prepare the disk for use by "formatting" it. Follow these simple instructions:

1. The Start-Up Utility Main Menu (As shown on page 9) should appear on the screen.
2. Type in the letter "C". This option formats your hard disk drive. This should only be done once when the disk is first used. This option completely erases all information on the hard disk, so be careful when running this option.
3. The system displays the question: "Drive C is a fixed disk drive. Do you want to completely erase it?" Type in "Y" to format the hard disk drive.

If the hard disk did not come built-in to the unit from the factory, you can add one yourself. Any hard drive compatible with the IBM PC-XT can be used. You must also purchase a hard disk controller that works with the drive you select.

Hard disk and disk controller installation varies depending on the model you select. You will need to do a low-level format on the disk before using the Start-Up Utility to do the high-level format. Consult the manual that comes with the hard disk for specific instructions

Chapter 5: Trouble Shooting Checklist

Symptoms and Suggestions

Symptom

Suggestions

No response from the main unit.

- The ON/OFF switch should be in the ON or "1" position.
- Make sure the outlet itself works.
- The power plug may be improperly connected to the back of the system unit.

No screen display.

- Monitor cable is not properly connected to the Monochrome Graphics/Color Graphics Card
- Monitor power cable is not plugged in properly
- The monitor's power switch is not turned on.
- The brightness or contrast knobs on the monitor are not properly adjusted.
- The small slide switch on the Monochrome Graphics/Color Graphics Card is not set correctly. Set to "MDA" for monochrome TTL monitors, or "CGA" for RGB color monitors.

Poor screen display quality

- Brightness or contrast knobs on the monitor are not properly adjusted.

Symptom

No response from the keyboard.

Disk drive error.

Suggestions

- Keyboard cable not properly connected. Check to make sure it's plugged in properly on the back of the system unit.
- System crash. Restart your system using the reset button on the back of the system unit. If necessary, turn your unit off, then on again.
- Keyboard lock is not off.
- Latch on the disk drive is not closed properly.
- The diskette was not placed in the drive correctly. Make sure the label points up, with the write-protect notch pointing to the left.
- You are using the wrong disk for start-up. Make sure you are using an MS-DOS System Disk.
- The diskette is damaged.
- The diskette is unformatted.

If none of these measures work, contact your computer dealer.

Beeps

1 Long + 1 Short

Base 64K RAM isn't usable. Check the RAM chips.

1 Long + 2 Short

The video selector switch on the Monochrome Graphics/
Color Graphics Card isn't properly set.

1 Long + 5 Short

BIOS ROM checksum is incorrect. Replace the BIOS chip.

Display Messages

<u>Message</u>	<u>Cause & Suggested Solution</u>
Video error.	<ul style="list-style-type: none">• BIOS couldn't find the type of display adapter requested by the switch settings.• Check the DIP switches and switch on the Monochrome Graphics/Color Graphics Card
Keyboard Error 0100.	<ul style="list-style-type: none">• Keyboard did not respond.• Check the connector on the keyboard.
Keyboard Error 02XX.	<ul style="list-style-type: none">• Keyboard returned the wrong test code xx.• Replace the keyboard.
Keyboard Error 04XX.	<ul style="list-style-type: none">• Keyboard interrupt would not clear.• Check Gate Array on the motherboard, or replace the keyboard.
Memory Address Error	<ul style="list-style-type: none">• Problem with memory addressing. Possibly unconnected RAM legs or shorted address lines.• Check the RAM chips by replacing one at a time.

For errors generated by the MS-DOS operating system, consult the *MS-DOS User's Guide*.

CHAPTER 6: Further Reading

There are many popular books on the market written about IBM PC-XT Compatible computers and the MS-DOS Operating System.

Whether searching for a good tutorial for beginners or an advanced reference manual for experts, you can certainly find a book geared toward your specific needs.

Here is a partial list of books available in retail stores or public libraries. There are hundreds of other relevant books in print. Consult your local library for a more complete listing.

These books are available from Howard W. Sams & Co. Call 1-800-428-SAMS for a dealer near you:

Kate O'Day, Discovering MS-DOS (4th Printing, 1987)

Steven Simrin, *MS-DOS Bible* (4th Printing, 1986)

Angermeyer, Fahringer, Jaeger, and Shafer, *Tricks of the MS-DOS Masters* (1st Printing, 1987)

O'Day and Angermeyer, *Understanding MS-DOS* (3rd Printing, 1987)

Other books available from computer retailers and book stores include:

Quick and Easy PC-DOS/MS-DOS, *Alfred Publishing Company, Inc.*

Your IBM-PC Made Easy, *Osborne/McGraw-Hill*

Your IBM: A Guide to the IBM-PC, *Osborne/McGraw-Hill*

Learning DOS, *Microsoft Corporation*

How to Use Your IBM-PC, *American Training International*

Teach Yourself PC-DOS, *American Training International.*

Appendix 1: Dip Switches and Settings

Switch Box #1 (SW1)

Position 1: Diagnostics

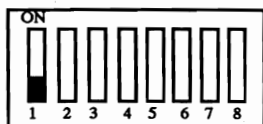

Normal operation

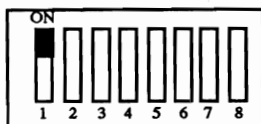

Factory testing only

Position 2: 8087-1 Math Co-Processor

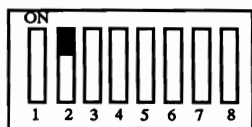

Without 8087 co-processor

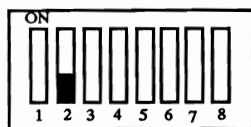

With 8087 co-processor

Position 3 Conventional Memory Amount

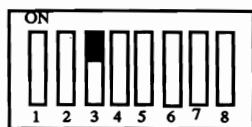

512K conventional
Memory

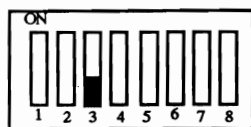

640K conventional
Memory Installed

Position 4 : Not Used

Position 5 & 6: Type of Display



Enhanced Graphics Adaptor
or Video Graphics array (VGA)

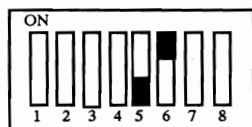

Color graphics adaptor
40 x 25 mode



Color graphics adaptor
80 x 25 mode

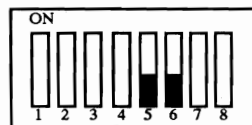

Monochrome display adaptor or
Hercules graphics card

Position 7 & 8: Floppy Disk Drives

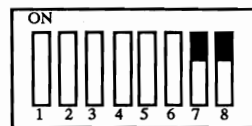

One (1) floppy drive

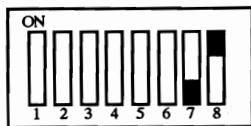

Two (2) floppy drives

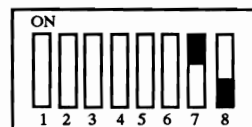

Three (3) floppy drives

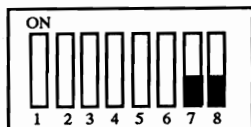

Four (4) floppy drives

Switch Box #2 (SW2)

Switch SW2 is used for setting the I/O Port address for the expanded memory installed in the computer. If you have up to one megabyte of expanded memory, the settings are easy.

The position of switches 1, 2 and 3 on SW2 determine the I/O port address of the expanded memory.

I/O Port Address



Appendix 2: The Multi I/O Card

The multifunction input/output (Multi I/O) card installed in the computer gives you several powerful features packed into a single expansion card. You get:

- Centronics Parallel Printer Port
- RS232C Serial Port
- Joystick Port
- A Real-Time Clock
- Floppy disk interface

On the Multi I/O Card, you'll find two jumper blocks. Jumper JP1 is used for setting the interrupt request levels for the real time clock. In reality, you should never have to change the setting of JP1.

Jumper JP2, shown below, is responsible for configuring the ports on the Multi I/O card:

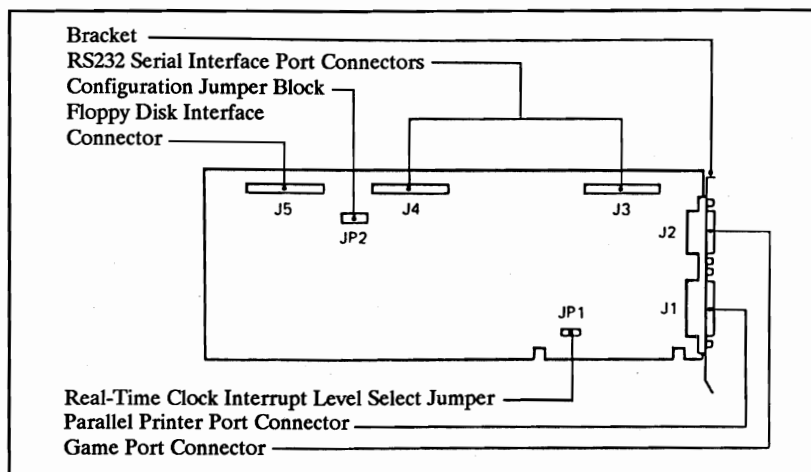

Notice how the jumpers are set when the unit leaves the factory:



The letters under each row are for illustration only. They do not actually appear on the jumper block.

Row A: Printer Port Enable

Top of the card



A

Parallel Printer
Enabled

Top of the card



A

Parallel Printer
Disabled

Row B: Printer Port Address

Top of the card



B

LPT1

Top of the card



B

LPT2

Row C: Real Time Clock Address

Top of the card



A

340H

Top of the card



A

2C0H

Row D: Serial Port COM2

The Multi I/O card normally has only one serial port named COM1. If you wish to purchase additional hardware, you can add a second serial port named COM2. Contact your dealer for details.

Top of the card



D

COM2 Enabled

Top of the card



D

COM2 Disabled

Row E: Floppy Disk Enable

Top of the card



E

Floppy Disk Enabled

Top of the card



E

Floppy Disk Disabled

Row F, G, H: Not Used

Row I: Serial Port COM1

Top of the card



I

COM1 Enabled

Top of the card



I

COM1 Disabled

Parallel Printer Port

Used for connecting a parallel printer with Centronics standard input. It is fully compatible with the IBM PC-XT parallel printer port.

<u>Pin #</u>	<u>Description</u>	<u>Pin #</u>	<u>Description</u>
1	-STROBE	10	-ACK
2	DATA 0	11	+BUSY
3	DATA 1	12	+PE
4	DATA 2	13	+SELECT
5	DATA 3	14	-AUTO FD
6	DATA 4	15	-ERROR
7	DATA 5	16	-INIT
8	DATA 6	17	-SELECT INPUT
9	DATA 7	18-25	GROUND

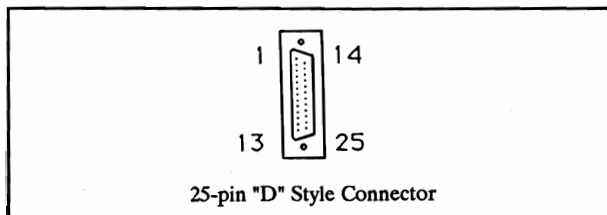

RS232 Serial Port

Used for connecting a serial printer or modem with RS232 standard input. It is fully compatible with the IBM PC-XT serial port.

<u>Pin #</u>	<u>Description</u>
1	CHASSIS GROUND
2	TRANSMIT DATA
3	RECEIVE DATA
4	REQUEST TO SEND
5	CLEAR TO SEND
6	DATA SET READY
7	SIGNAL GROUND
8	CARRIER DETECT
20	DATA TERMINAL READY
22	RING INDICATOR
OTHERS NOT USED	

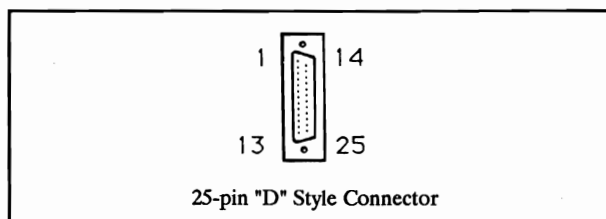

Joystick Port

Used for connecting a joystick mechanism to the Laser Turbo XT using a 15-pin "D" style connector.

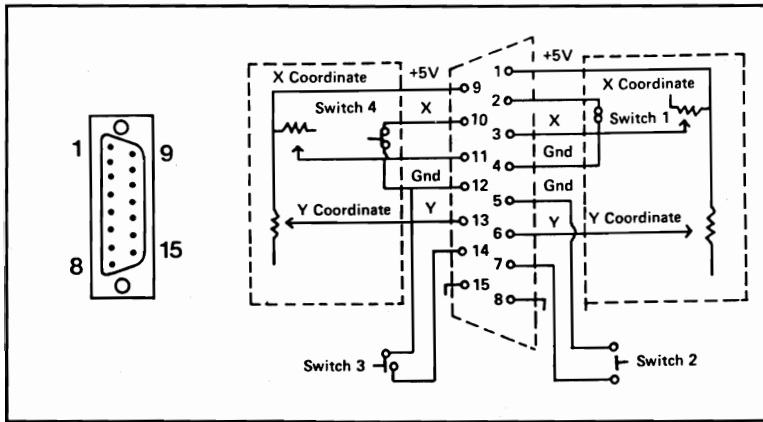

Appendix 3: Monochrome Graphics /Color Graphics Card

Overview

As a color graphics adapter, this card provides a flexible interface to RGB monitors, as well as color and monochrome composite monitors. Graphic resolutions of 320 x 200 or 640 x 200 are available.

When selected for monochrome operation, the Monochrome Graphics/Color Graphics Card is fully compatible with the Hercules graphics card, providing 720 x 348 resolution.

When the Monochrome Graphics/Color Graphics Card is installed in a Laser Computer, the slide switch on the card faceplate is used to select color graphics or monochrome operation.

MDA
CGA



Once you have set pole 5 and 6 or the DIP switch SW1 to ON, there are no other switches to set, and no need to open the system unit. The Laser BIOS on the graphics adapter assures perfect operation when inside a Laser Computer.

Using the Adapter in Non-Laser Computers

If you install the Monochrome Graphics/Color Graphics Card in a non-Laser computer, or the Monochrome Graphics/Color Graphics Card coexists with another graphics card (e.g. EGA, CGA or MDA). You may have to disable the Laser BIOS built in to the graphics card.

When you disable the built-in BIOS, you will need to set the DIP switches inside the non-Laser computer to match the MDA/CGA slide switch on the card's faceplate.

To disable the built-in BIOS:

1. Locate the Jumper JP2 on the Graphics Adapter.

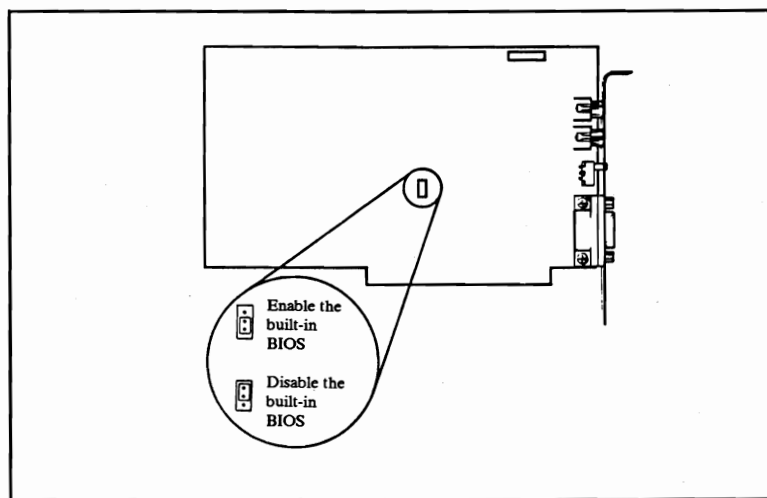

2. Move the jumper so it covers pins 2 and 3 on JP2.

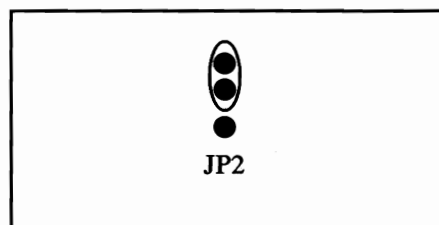

With the jumper set in this manner, the BIOS on the Monochrome Graphics/Color Graphics Card is disabled.

If your Laser computer is installed with EGA card, please refer to user manual provided for the EGA card:

If your Laser computer is installed with hard disk controller card please refer to the user manual provided for the hard disk controller.

Appendix 4: Glossary of Computer Terms

As with any industry, the computer world seems to have a language all its own. Listed below are some of the most common words and phrases you will see in relation to personal computers.

8087 Coprocessor

The 8087 is a computer chip designed to work with the computer's main microprocessor. The 8087 chip is designed specifically to speed up mathematical calculations for large spreadsheets, etc.

8086

The 8086 is a main microprocessor chip. This chip could be considered the "brain" of an IBM or compatible computer because the 8086 chip processes all of your computer's commands. When you program your computer to do something, the 8086 chip receives your commands, and executes them.

8086-1

The 8086-1 chip is an improved version of the 8086 chip. The 8086-1 replaces the 8086 and performs the same functions that the 8086 chip does. However, the 8086-1 is a "turbo" computer chip. The 8086-1 can run at a speed of either 4.77 MHz or the turbo/faster speed of 10 MHz.

Some IBM software programs are designed to run only at 4.77 MHz. To run these programs, your computer would need a microprocessor that runs at 4.77 MHz. However, many software titles written today are more flexible. You can run them at either 4.77 MHz, or you can run them at "turbo speed". The advantage to owning a computer with a turbo chip like the 8086-1 is that your computer can execute commands and work for you faster when software allows it to. Happily, almost all IBM software these days lets you take advantage of this turbo speed feature.

AT Style Keyboard

IBM has manufactured a few different models of personal computers (PC, PC JR., PC/XT, PC/AT). The PC/AT style keyboard is generally considered to be superior. The AT style keyboard is designed to feel like an IBM Selectric typewriter and has large SHIFT and RETURN keys. It is often said that the AT style keyboard feels more comfortable and is easier to work on because of its features.

BIOS

BIOS stands for Basic Input/Output System. The BIOS is the central computer program which organizes your entire computer. The BIOS acts much like a computer "road map". The BIOS contains a list of computer locations for everything inside of your computer from computer chips to floppy disk drives. When the microprocessor needs to send a signal, it asks the BIOS how to get there.

As an example - you instruct your computer to read information from disk drive "B". The microprocessor receives your command. It then asks the BIOS where disk drive "B" is located. At this point, the BIOS will give the microprocessor specific directions from the location of the microprocessor chip to the location of the disk drive. The microprocessor will then send an electrical impulse along the route the BIOS has described, and this signal will instruct the disk drive to begin reading information. Without the BIOS, your microprocessor would be "all dressed up, with no place to go".

Boot Up

This is a slang term used to describe the computer's start-up procedure. You boot up your computer when you turn power to your computer "on".

Bracket

Brackets are the narrow metal pieces which cover the eight holes on the back of your computer. The eight holes correspond to the eight expansion slots in your computer. Brackets are used for two main purposes: one, they help anchor expansion cards securely; and two, they cover the openings for empty expansion slots so that dust and dirt can not enter your computer and damage it.

CGA

CGA stands for Color Graphics Adaptor.

Clock

A clock keeps time, and computers can have the option of a clock installed. This option can be used many ways, but the main idea is always the same. If you have a clock in your computer, it will keep time for you.

Cold Start

When all power to your computer is turned off, and you then turn power to your computer "on", you have "cold started" your computer.

COM

COM is the computer abbreviation for a serial computer port. Computers can be configured for more than one serial port. Because of this, COM ports are always designated as COM1, COM2, COM3, etc.

Configure

To configure means to specifically set something up a certain way. When a computer dealer says that his computer is "factory pre-set", he means that the computer has been configured or set-up a certain way.

Conventional Memory

MS DOS regularly addresses (or accesses) a maximum of 640K RAM. Therefore, 0K to 640K RAM is considered conventional memory.

DIP Switch

The DIP in DIP switch stands for Dual In-line Package. DIP switches on your computer must be turned either "on" or "off" in order to tell your computer some very basic information. The main DIP switches inform the computer how much memory is installed, how many floppy disk drives there are, etc. The computer uses this critical information to test and orient itself every time the power is turned on. If a DIP switch is set incorrectly, your computer may not function properly.

DIN Connector

A DIN connector is a round plug connection. The most common type of DIN connector is a five pin DIN connector, which is a round plug with five pins (male connector) or five holes (female connector).

DSDD

DSDD stands for Double Sided Double Density, and refers to floppy diskettes. DSDD disks are the most common type of floppy disks used on IBM and compatible computers. You can store more information on DSDD disks than on SSDD (Single Sided Double Density) disks, because DSDD diskettes can hold information on both sides of the diskette.

EGA

EGA stands for Enhanced Graphics Adaptor, providing a much higher quality picture on your computer's monitor.

EMS

EMS stands for Expanded Memory Specification. Some software such as Lotus 1-2-3 uses EMS. The conventional computer memory maximum is 640K. EMS is a set of standards where programs can use up to eight megabytes of memory, above beyond the 640K barrier.

Expansion Card

An expansion card is a device you plug into a computer which allows you to add new features. Expansion cards are delicate electronic instruments, and should be handled with care. Expansion cards come in a variety of sizes (7", 10", and even full length 14" sizes).

Expansion cards are inserted in your computer's expansion slots. At the bottom of each expansion card you will find a 62 "gold fingered" band (31 gold stripes on each side). The gold fingers connect the card to your computer's main circuitry. The expansion cards are secured in their slots by brackets which are firmly screwed into the main unit casing. Real gold is used on the gold fingers so that the expansion cards are not susceptible to tarnishing. Tarnishing can interfere with an expansion card's connection to the motherboard.

Expansion Slot

Your Computer computer has eight expansion slots. They are located on the left hand side of the computer at the rear. These expansion slots can be used to add features to your computer via expansion cards.

Female

A female connector on a computer will have holes (in comparison to a male connector which will have pins).

Floppy Diskette

A floppy diskette is a disk which contains magnetic media. A floppy disk is used to store information. The information is stored on a floppy disk via the read/write head of your floppy disk drive.

Floppy Disk Drive

Floppy disk drives read (retrieve) or write (save) information on floppy diskettes.

Formatted

Formatted diskettes are "mapped out". When you format a disk, the disk drive creates divisions ("sectors") on the diskette, and numbers them. With this, data that is saved on a formatted disk can be located in, say, sector 1, etc. Formatting gives your computer the ability to locate data with precise coordinates on each floppy diskette.

Hard Disk Drive

A hard disk drive (or fixed disk) can store much more information than a floppy disk drive. A hard drive is made of many layers of special magnetic media, specifically designed to hold high quantities of data. As a rough example, installing a 20 MB hard drive in your computer is like adding 125 floppy disk drives to that same computer. A hard disk allows you to access information more rapidly, because you do not have to repeatedly load floppy diskettes.

One note of caution - because a hard drive is made up of so many layers of specialized magnetic media, it is much more delicate. Use care when handling or moving a computer with an installed hard drive, and carefully read all precautions before handling or moving any hard disk drive.

Hardware

Hardware is considered to be any part of your computer that you can actually touch (in contrast to software which is considered to be information stored on magnetic media/floppy diskettes). Items of hardware include printers, monitors, floppy disk drives, etc.

Hercules/Hercules-Compatible

Hercules or Hercules-compatible is a monitor display standard of 720H x 350V resolution. 720 refers to the number of tiny dots (called "pixels") appearing across the screen.

I.C. Socket

I.C. socket stands for Integrated Circuit socket. An I.C. socket is a location on the computer motherboard where you can insert a computer chip without soldering.

Initializing Diskettes

When you initialize a floppy diskette, you are "formatting" the floppy diskette. See *formatted*.

LPT

LPT is an abbreviation for computer parallel ports. Since computers can have more than one parallel port, parallel ports are always designated LPT1, LPT2, LPT3, etc.

Male

Male computer connectors have pins (as compared to female connectors, which have holes).

MHz

MHz is the abbreviation for Megahertz. Megahertz is a unit of measurement for computer's microprocessor speed.

Microprocessor

See *8086* or *8086-1*.

Monochrome

Monochrome means "single color" displays. Typical monochrome monitors are either green or amber with black backgrounds.

Motherboard

The motherboard is the main circuitry board of your computer which houses all computer microcircuitry and offers room for expansion via I.C. sockets and expansion slots.

Nanoseconds

Nanoseconds are very small increments of time (one *billionth* of a second). Nanoseconds are used as a rating method for RAM chips; the lower the number of nanoseconds, the faster the RAM chip. 120 nanosecond (or "ns") chips are faster/better quality than 150ns chips.

Parallel Port

Parallel ports are computer ports typically used for parallel Centronics printer hook-up.

RAM

RAM stands for Random Access Memory. You can read or write to RAM memory (versus ROM memory, which you can only read from). RAM memory is dynamic, you can change RAM memory contents by adding to or deleting from RAM at your discretion.

Re-Boot

"Re-booting" your computer means to restart the computer from scratch.

Read

When you read information from a floppy disk, you are retrieving information that has been stored on the diskette.

Real Time Clock

A real time clock keeps time for your computer even when it is turned off (real time clocks traditionally have a battery back-up). A real time clock is an optional accessory for IBM XT's which frees you from having to repeatedly enter the date and time every time you boot MS DOS.

Resolution

Every monitor display picture you see is made up of tiny dots (called pixels). Resolution is typically given in terms of horizontal dots by vertical dots. The more dots (pixels) in the resolution, the clearer your picture will be.

As an example - 640H x 200V (a typical CGA color resolution) is not as good, or as clear, as 640H x 350V (typical EGA color resolution).

RGB

RGB stands for Red-Green-Blue. RGB is a term used to describe one type of monitor display for your computer. RGB monitors are color monitors which divide, and then recombine the picture signal so as to make the picture clearer.

ROM

ROM stands for Read Only Memory. ROM memory is information your computer can readily access, necessary information. ROM memory differs from RAM memory in that you can not "write" or save information to the ROM memory locations. The only thing you can do to ROM memory is retrieve, or read, from it.

Serial Port

A computer serial port is typically labelled as a communications port. A serial port can be used to hook up either a serial printer or a modem, both of which "communicate" between the computer and the outside world.

Software

Software is best described as any information you load (or +read+) into your computer. Software is contained on floppy diskettes. Typically, software allows you to do something with your computer (i.e. play a game, write a letter, or design a spreadsheet for mathematical calculations).

Turbo

Turbo is a term used to mean "faster speed". A turbo computer (like your computer) runs at a faster speed than other computers. Turbo computers work faster, giving you the advantage of being done faster with whatever it is you want to do.

TTL

TTL stands for Transistor-to-Transistor-Logic. TTL is a term used to describe one type of display monitor. TTL monitors are typically monochrome monitors that will always give you a crisper picture, due to their advanced +transistor logic.

Write

When you save information you are +writing+ information to your floppy diskette or hard disk drive. +Write+ is the technical term for saving information to your computer.

Write Protect

Every floppy diskette has a notch (or cut-out portion) on it. This notch allows the computer disk drive heads to write information onto the floppy disk. When you cover this notch, you can not write information onto the floppy disk. Write protect "tabs" are typically included with floppy diskettes when purchased so that you can use this safeguard measure for important data.

Warm Boot

Restarting your computer using the Reset Button on the back of the system unit or the CTRL-ALT-DEL key sequence.

91-2124-13

©1988 VTCL. Printed in Hong Kong